

Technical Information



The intent of this section of the catalogue is to identify important features that may be useful in the selection and installation of explosion protected electrical equipment.

There are numerous different regulations, codes, guidelines and standards for the design, installation and maintenance of electrical and non-electrical systems for use in potentially explosive atmospheres. The type of operational facility, geographic location, operator practice, local and national legislation, authority having jurisdiction, will determine many of the design and installation rules permitted. A fixed or floating petroleum facility located offshore for example would not be designed or classified in the same manner as an onshore petrochemical facility.

1.0 Potentially Explosive Atmospheres

An explosive atmosphere is defined as:

- Flammable substances in the form of gases, vapours, mists, dusts or fibres mixed with air and/or
- Under atmospheric conditions, which after ignition has occurred, combustion spreads to the entire unburned mixture.

2.0 Area Classification (Classification of Locations)

The purpose of area classification is to provide a basis for the correct selection, installation and location of electrical and non-electrical equipment in those areas. Areas must be classified depending on the properties of the flammable vapours, liquids, gases, mists, combustible dusts or fibres that may be present and the likelihood that a flammable or combustible concentration or quantity is present.

The aim of area classification is to avoid ignition of flammable releases that may occur in the operation of facilities. The intent is to reduce to an acceptable minimum level the probability of a flammable atmosphere and an ignition source occurring at the same time.

3.0 IEC

3.1 Area Classification

Area classification is the division of a facility into three dimensional hazardous areas and non-hazardous areas and the sub-division of the hazardous area into Zones.

Hazardous areas may be sub-divided into three Zones, as shown below:-

FLAMMABLE GASES AND VAPOURS	
Zone 0	An area in which an explosive atmosphere is constantly present, or present for long periods.
Zone 1	An area in which an explosive atmosphere is likely to occur in normal operation. (Rough Guide: 10 hours or more per year but less than 1,000 hours per year)
Zone 2	An area in which an explosive atmosphere is not likely to occur in normal operation and if it occurs it will exist only for a short time. (Rough Guide: Less than 10 hours per year)

COMBUSTIBLE DUSTS	
Zone 20	An area in which combustible dust, as a cloud, is present continuously or frequently during normal operation in sufficient quantity to be capable of producing an explosive concentration of combustible dust in a mixture with air.
Zone 21	An area in which combustible dust, as a cloud, is occasionally present during normal operation in a sufficient quantity to be capable of producing an explosive concentration of combustible dust in a mixture with air.
Zone 22	An area in which combustible dust, as a cloud, may occur infrequently and persist for only a short period, or in which accumulations of layers of combustible dust may give rise to an explosive concentration of combustible dust in a mixture with air.

For further information on the classification of hazardous areas, please refer to the following publications:-

- IEC/EN 60079-10** Electrical apparatus for explosive gas atmospheres. Classification of hazardous areas.
- Energy Institute** Model code of safe practise in the petroleum industry.
(Formerly Institute of petroleum) E115 Area Classification Code for Petroleum installations.

3.2 Classification Society

A Classification Society may also enforce requirements for the design of installations of facilities. These requirements, which are in addition to statutory requirements, may influence the design and installation of the electrical systems. **Classification Societies include ABS, DNV and Lloyds Register.**

3.3 Design and Installation of Electrical Systems for Hazardous (Classified) Areas

There are numerous regulation codes, guidelines and standards for the design, selection and installation of electrical equipment in potentially explosive atmospheres. These requirements are in addition to the requirements for installations in non-hazardous areas.

There are several types of protection, i.e. construction techniques, available for electrical apparatus in hazardous areas. The type of protection permitted will depend upon the applicable installation codes and rules to be adopted.

The selection of electrical apparatus should be in accordance with the following: -

- Classification of the hazardous area.
- Temperature class or ignition temperature of the gas, liquid, vapours, mist, dust or fibre.
- Where applicable, the gas, vapour or dust classification in relation to the group or sub-group of the electrical apparatus.
- External influences and ambient temperature.

3.4 Apparatus Selection According to Zones

3.4.1 Apparatus for use in Zone 0

- Intrinsic safety 'ia'.

3.4.2 Apparatus for use in Zone 1

- Electrical apparatus permitted for use in Zone 0, or
- Flameproof enclosure 'd'.
- Pressurised apparatus 'p'.
- Powder filling 'q'.
- Oil immersion 'o'.
- Increased safety 'e'.
- Intrinsic safety 'ib'.
- Encapsulation 'm'.

3.4.3 Apparatus for use in Zone 2

- Electrical apparatus permitted for use in Zone 0 and Zone 1, or
- Electrical apparatus designed specifically for Zone 2 (e.g. type of protection 'n') or
- Electrical apparatus complying with the requirements of a recognised standard for industrial electrical apparatus, which does not, in normal operation, have ignition-capable hot surface and does not in normal operation produce arcs or sparks. This equipment must be in an enclosure with a degree of protection and mechanical strength suitable for the environment and be assessed by a person who is familiar with the requirements of any relevant standards and codes of practice.

3.4.4 Apparatus for use in Zones 20, 21 and 22

- IEC/EN 61241-0– Electrical apparatus for use in the presence of combustible dust. General requirements.
and
- IEC/EN 61241-1 – Electrical apparatus for use in the presence of combustible dust. Protection by enclosures 'tD'.

3.5 Apparatus selection according to the ignition temperature of the gas or vapour

The equipment must be selected so that its maximum surface temperature will not reach the ignition of any gas or vapour that may be present.

TEMPERATURE CLASS OF ELECTRICAL APPARATUS	MAXIMUM SURFACE TEMPERATURE OF ELECTRICAL APPARATUS	IGNITION TEMPERATURE OF GAS OR VAPOUR
T1	450°C	>450°C
T2	300°C	>300°C
T3	200°C	>200°C
T4	135°C	>135°C
T5	100°C	>100°C
T6	85°C	>85°C

If the marking of the electrical apparatus does not include an ambient temperature range, the apparatus is only for use within an ambient temperature range from -20°C to +40°C.

3.6 Apparatus selection according to apparatus grouping

The grouping of gases and vapours are classified into Group I and Group II categories. Group I is relevant to atmospheres containing firedamp (a mixture of gases, composed mostly of methane, found underground in mines).

Group II is intended for use in all other places with potentially explosive atmospheres. Group II electrical apparatus with types of protection 'd' and 'i' are further sub-divided into apparatus group IIA, IIB or IIC. Electrical apparatus with type of protection 'n' may also be sub-divided if it contains certain devices or components.

GAS / VAPOUR SUB-DIVISION	APPARATUS SUB-GROUP PERMITTED
IIA (typical gas propane)	IIA, IIB or IIC
IIB (typical gas ethylene)	IIB or IIC
IIC (typical gases acetylene and hydrogen)	IIC

3.7 Apparatus Construction Standards

- IEC/EN 60079-0 - General Requirements
- IEC/EN 60079-1 - Flameproof Enclosure 'd'
- IEC/EN 60079-2 - Pressurisation 'p'
- IEC/EN 60079-5 - Powder Filling 'q'
- IEC/EN 60079-6 - Oil Immersion 'o'
- IEC/EN 60079-7 - Increased Safety 'e'
- IEC/EN 60079-11 - Intrinsic Safety 'i'
- IEC/EN 60079-15 - Electrical Apparatus type 'n'
- IEC/EN 60079-18 - Encapsulation 'm'
- IEC/EN 61241-1 - Dust protection by enclosure

3.8 Installation Standards and Codes

There are numerous different regulations, codes, guidelines and standards for the design, installation and maintenance of electrical and non-electrical systems for use in potentially explosive atmospheres. The type of operational facility, geographic location, operator practice, local and national legislation, authority having jurisdiction etc. will determine many of the design and installation rules permitted.

For further information on the design, selection and installation of equipment for use in hazardous areas see: -

- IEC/EN 60079-14 - Explosive atmospheres. Electrical installations design, selection and erection.
- IEC/EN 61892-7 - Mobile and fixed offshore units. Electrical installations. Hazardous areas.
- IEC/EN 61241 - Electrical apparatus for use in the presence of combustible dust. Protection by enclosures 'tD'.

3.9 Inspection Standards and Codes

For information regarding the installation and maintenance of equipment for use in hazardous areas, see:-

- IEC/EN 60079-17 - Explosive atmospheres. Electrical installations inspection and maintenance.

4.0 ATEX 94/9/EC Directive

ATEX is the term used when referring to the European Union's (EU) Directive 94/9/EC.

The ATEX Directive main objectives are to guarantee the free circulation of goods within the European Union by aligning the technical and legal requirements of the Member States.

'ATEX' is derived from the French 'Atmosphères Explosibles'.

The Directive is named: - "Approximation of the laws of the Member States concerning equipment and protective systems intended for use in potentially explosive atmospheres".

The Directive covers electrical and non-electrical equipment and protective systems intended for use in potentially explosive atmospheres in mining and surface industries.

The Directive covers:-

- Equipment and products that have potential ignition sources.
- Protective systems – products that control the effects of incipient explosions.
- Safety Devices – products that may be outside a potentially explosive atmosphere but that have an explosion safety function.
- Components – products that are intended to form parts of equipment or protective systems.

To ensure compliance with the Directive, equipment must meet with the essential requirements specified in the Directive and be marked with the CE marking.

The process of ensuring that equipment complies with the Directive, conformity assessment procedure(s) must be complied with. These procedures may involve a Notified Body. A Notified body is a body that is independent of the product manufacturer and assesses conformity of the products and the manufacturer with the Directive. The Notified Body has to be approved and appointed by its government.

Conformity assessment procedures include, but are not limited by:-

- **EC Type Examination** – including testing and inspection of a product design, where appropriate.
- **Production Quality Assurance** – including the assessment, periodic auditing, testing and inspection of production samples, where appropriate, and of the manufacturers quality system.
- **Product Verification** – the inspection and/or testing of each production item for conformity with the type that was subjected to EC Type Examination.
- **Internal Control of Production** – the verification by the manufacturer that the product design and each production item conform to either harmonized European Standards or the essential requirements or a combination of the two.

The ATEX Directive came into force on a voluntary basis on 1st March 1996 and became mandatory from the 1st July 2003 and all products within its scope have to comply before being placed on the market or put into service.

The Directive classifies equipment into eight categories depending on the equipment's area of use:-

CATEGORY	DESCRIPTION
M1	Equipment intended for mining use and required to remain functional in the presence of an explosive atmosphere.
M2	Equipment intended for mining use, but is intended to be de-energised in the event of an explosive atmosphere.
1G	Non-mining equipment for use in Zone 0.
2G	Non-mining equipment for use in Zone 1.
3G	Non-mining equipment for use in Zone 2.
1D	Non-mining equipment for use in Zone 20.
2D	Non-mining equipment for use in Zone 21.
3D	Non-mining equipment for use in Zone 22.

4.1 ATEX 137 Directive 99/92/EC

The Directive covers the use of equipment in potentially explosive atmospheres and its aim is to establish minimum requirements for improving the safety and health of workers.

Article 137 of Directive 89/391/EC was published in the official journal of the EC on 28th January 2000 as Directive 99/92/EC, it is the 15th individual Directive of the framework Directive 89/391/EEC.

The article defines the: -

- Obligations of the employees re. the prevention and protection against explosions
- Assessment obligations re. the assessment of explosion risks
- General obligations re. the safety and health of worker
- Requirements for explosion protection documents

In places where potentially explosive atmospheres may occur in such quantities as to endanger the health and safety of workers, the point of entry must be marked with the sign shown in accordance with Section II, Article 7 of the Directive.



5.0 Wiring Systems

Cable systems and accessories should be installed in positions that prevent them from being subject to mechanical damage, corrosion, chemical attack, heat and other detrimental environmental conditions.

Selection of the wiring system and cable type must consider these influences and where exposure to such conditions are unavoidable, protective measures such as minimising the risk of mechanical damage by the use of appropriate armoured cable types should be considered.

The connection of cables and conduits to the electrical apparatus must be in accordance with the requirements of the relevant type of protection and installation rules.

5.1 IEC Wiring Methods

With the introduction of cables incorporating new construction materials and especially cables with fire retardant or fire resistant properties such as cables complying with IEC 60331 and IEC 60332, cables may exhibit 'cold flow' characteristics. 'Cold flow' is a term used for thermoplastic materials that flow when subjected to pressure at ambient temperature. These 'cold flow' characteristics could have adverse effects on the protection of the apparatus. A suitable cable gland should be used that does not incorporate displacement/compression seals that act upon the part(s) of the cable having cold flow characteristics.

To overcome this problem, Hawke has developed cable glands that incorporate diaphragm seals that act upon the 'cold flow' cable sheath without compressing or damaging the cable. A typical cable gland incorporating displacement/compression seals and a Hawke 501/453/UNIV cable gland incorporating a diaphragm seal are shown below:

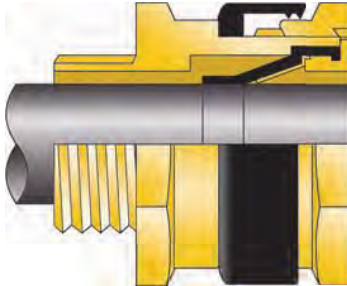

No cable damage due to Hawke 501/453 Universal diaphragm seal cable gland design.

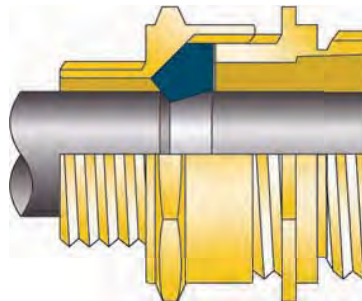

Cable damage as found with cable gland designs incorporating compression / displacements seals

The IEC installation standard IEC/EN 60079-14 addresses 'cold flow' in clause 9.3.10.

5.2 Extract from EN60079-14: 2008 / IEC 60079-14 :2007

(Acknowledgement: Extract from BS EN 60079-14: 2008 reproduced with the permission of BSI under licence no. PD/1998 1818 and 1920. Complete editions of the standard can be obtained from www.bsi-global.com)

Installations in hazardous areas

9.3.10 Connections of cables to equipment

The connection of cables to the electrical equipment shall maintain the explosion protection integrity of the relevant type of protection.

Where the certificate for the cable gland has an 'X' marking, this cable gland shall be only used for fixed installations. If an additional clamping is required to prevent pulling and twisting of the cable

transmitting the forces to the conductor terminations inside the enclosure, a clamp shall be provided and placed within 300mm of the end of the cable gland.

Where the equipment is portable only glands without 'X' marking shall be used.

Cable glands and/or cables shall be selected to reduce the effects of 'coldflow characteristic' of the cable.

Note 1: *Cables employ materials which may exhibit 'coldflow' characteristics. 'Coldflow' in cables can be described as the movement of the cable sheath under the compressive forces created by the displacement of seals in cable glands where the compressive force applied by the seal is greater than the resistance of the cable sheath to deformation. Low smoke and/or fire resistant cables usually exhibit significant cold flow characteristics. Cold flow could give rise to a reduction in the insulation resistance of the cable and, where reasonably practical, efforts should be made to prevent this by selection of suitable cable glands.*

Cable glands with tapered threads shall not be used in enclosures having gland plates with unthreaded entries.

Note 2: *Tapered threads include NPT threads.*

Hazardous Area Information

10.4 Cable Entry Systems

10.4.1 General

It is essential that cable entry systems comply with all the requirements referred to in the equipment standard and documentation. Cable glands shall:

- Be appropriate to the type of cable employed;
- Maintain the type of protection; and
- Be in accordance with 9.3.10

Where cables enter into flameproof equipment via flameproof bushings through the wall of the enclosure which are part of the equipment (indirect entry), the parts of the bushings outside the flameproof enclosure shall be protected in accordance with one of the types of protection listed in IEC 60079-0. For example, the exposed part of the bushings are within a terminal compartment which may either be another flameproof enclosure or will be protected by type of protection 'e'. Where the terminal compartment is Ex 'd', then the cable system shall comply with 10.4.2. Where the terminal compartment is Ex 'e', then the cable system shall comply with 11.2

Where cables enter into flameproof equipment directly, the cable system shall comply with 10.4.2.

10.4.2 Selection of cable glands

The cable entry system shall comply with one of the following:

- a) cable glands in compliance with IEC 60079-1 and certified as part of the equipment when tested with a sample of the particular type of cable.
- b) Where a cable, in compliance with 9.3.1 (a) is substantially compact; a flameproof cable gland, in compliance with IEC 60079-1, may be utilized, providing this incorporates a sealing ring and is selected in accordance with Figure 2.

Compliance with Figure 1 is not necessary if the cable gland complies with IEC 60079-1 and has been tested with a sample of specific cable to repeated ignitions of the flammable gas inside an enclosure and shows no ignition outside the enclosure.

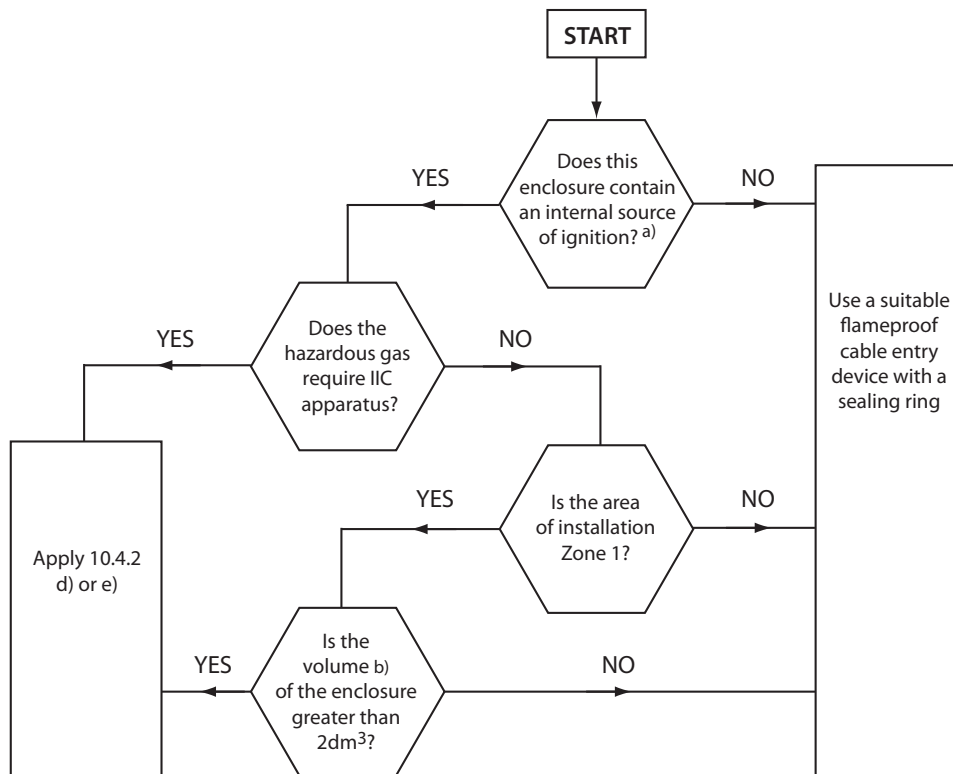

- a) Internal sources of ignition include sparks or equipment temperatures occurring in normal operation which can cause ignition. **An enclosure containing terminals only or an indirect entry enclosure (see 10.4.1) is considered not to constitute an internal source of ignition.**
- b) The term 'volume' is defined in IEC 60079-1)

Figure 2 – Selection chart for cable entry devices into flameproof enclosures for cable complying with item b) of 10.4.2

- c) Mineral-insulated metal-sheathed cable with or without plastic outer covering with appropriate flameproof cable gland complying with IEC 60079;
- d) Flameproof sealing device (for example a sealing chamber) specified in the equipment documentation or copying with IEC 60079-1 and employing a cable gland appropriate to the cables use. The sealing device shall incorporate compound or other appropriate seals which permit stopping around individual cores. The sealing device shall be fitted at the point of entry of cables to the equipment;

- e) Flameproof cable gland, specified in the equipment documentation or complying with IEC 60079-1, incorporating compound filled seals or elastomeric seals that seal around the individual cores or other equivalent sealing arrangements.

11.2 Wiring Systems

11.2.1 General

Cables and conduits shall be installed in accordance with Clause 9 of the following additional requirements concerning cable entries and conductor terminations.

Additional cable entry holes may be made into the enclosure providing this is permitted by the manufacturer’s documentation.

Note 1: Threaded holes in plastic enclosures should be **at right angles to the face of the enclosure** (due to the possible moulding methods for plastic enclosures, the wall of the enclosure may have draw angles). Surfaces with angles do not allow the gland and associated fittings inserted in the hole to fit square to the face, resulting in ineffective sealing.

Note 2: Taper threaded holes in plastic enclosures are not recommended because the high stresses created during sealing of these threads may fracture the enclosure wall.

11.2.2 Cable Glands

The connection of cables to increased safety equipment shall be effected by means of cable glands appropriate to the type of cable used. They shall comply with the requirements of IEC 60079-0.

Note 1: To meet the ingress protection requirement it may also be necessary to seal between the cable glands and the enclosure (for example by means of a sealing washer or thread sealant).

Note 2: In order to meet the minimum requirement of IP54, threaded cable entry devices into threaded cable entry plates or enclosures of 6mm or greater thickness need no additional sealing between the cable entry devices and the entry plate or enclosure providing the axis of the cable entry device is perpendicular to the external surface of the cable entry plate or enclosure.

Where mineral-insulated metal-sheathed cables are used, the requirement to achieve creepage distances shall be maintained by using an Ex ‘e’ mineral insulated cable sealing device.

Threaded adaptors complying with IEC 60079-0 may be fitted into the cable entry holes to allow connection of the device or cable gland.

Unused entries in the enclosure shall be sealed by blanking elements, which comply with IEC 60079-0 and maintain the degree of ingress protection IP54 or that required by the location, whichever is the higher.

- End of Extract-

5.3 Wiring Methods for Type of Protection 'e' – Increased Safety

The cable entry device, e.g. cable gland, must comply with all the requirements referred to in the appropriate standard, be appropriate to the cable type and maintain the type 'e' integrity of the equipment.

A minimum ingress protection rating of IP54 is required for increased safety equipment. To meet with this requirement it may be necessary to provide a seal between the cable gland and the equipment, for example, by the use of a sealing washer or thread sealant. Where cable glands are fitted into non-metallic enclosures, metallic enclosures with a painted type finish or enclosures with non-threaded clearance holes, additional ingress and earthing / bonding considerations may be necessary. Please refer to the sealing washer, earthtag, serrated washer and locknut accessories shown in the catalogue.

6.0 Apparatus Marking - IEC (Group II)

6.1 ATEX Marking (Glands)

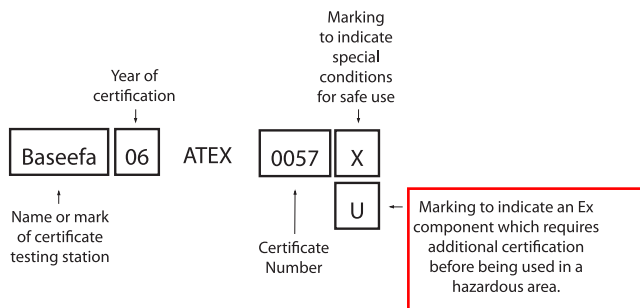
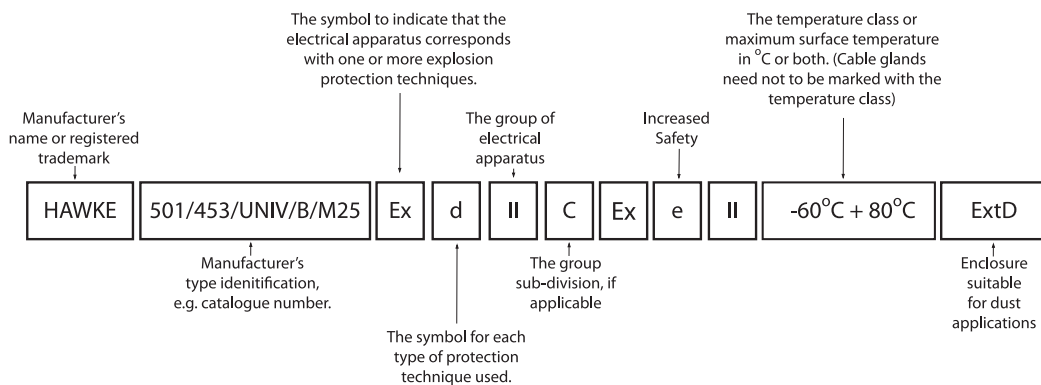

6.2 ATEX Marking (Enclosures)

- The name and address of the manufacturer.
- Type, serial number and the year in which the equipment was constructed.
- The specific marking of explosion protection (Ex) followed by the symbol of the equipment group and the category.
- IEC/EN 60079-0, IEC/EN 60079-7, IEC/EN 61241-0 and IEC/EN 61241-1 (Optional)

- 'Exell',
- Temperature Classification,
- IP Rating,
- Certification Name and Number,
- 'DO NOT OPEN WHEN ENERGIZED',
- Maximum Dissipated Power (Watts), Volts and Amps.

Note: If the temperature range is outside the normal range of -20°C to +40°C, it must be marked on the label.

- For equipment Group II:-

The letter 'G' where explosive atmospheres caused by gases, vapour or mists are concerned and/or the letter 'D' where explosive atmospheres caused by dusts are concerned.

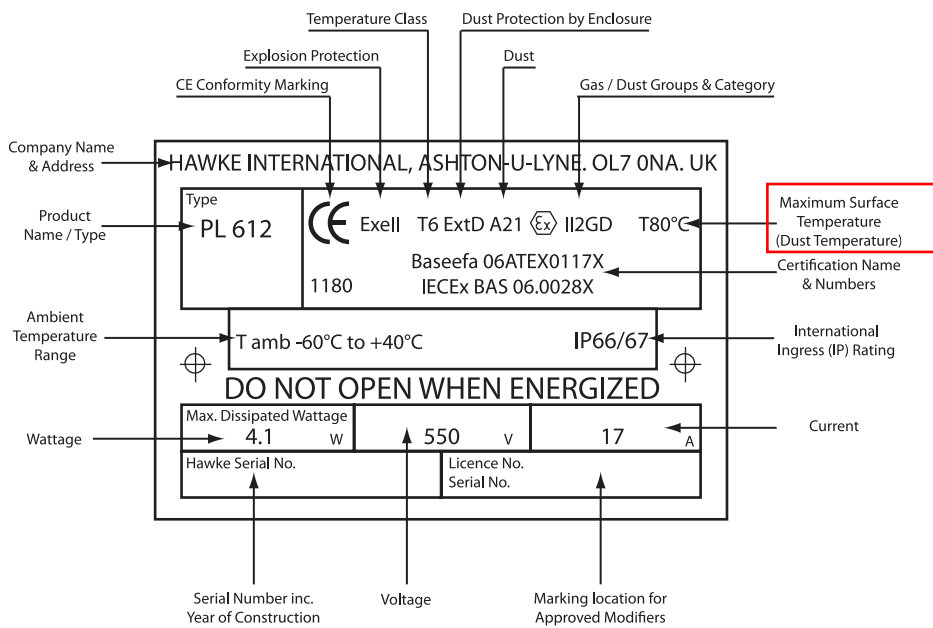

6.3 Additional CE Marking

The CE conformity marking must consist of the initials CE and be followed by the identification number of the notified body responsible for production control.

E.g. CE_{1180}

6.4 New Marking – EPL’s (Explosion Protection Levels)

The introduction of the EPL’s and changes in the EN 60079 and EN 61241 series standards has introduced new marking requirements.

6.4.1 Gas (Surface)

The gas group that was previously (II) for Increased safety in surface applications is now IIA, IIB or IIC, depending upon the certification.

6.4.2 Dust

Grouping has also been applied to dusts where the marking is differentiated from gases by the addition of another I i.e. IIIA, IIIB or IIIC.

6.4.3 Explosion Protection Levels

The explosion protection levels are identified by their lettering:-

GASES	TYPICAL ZONE	DUSTS	TYPICAL ZONE
Ga	0	Da	20
Gb	1	Db	21
Gc	2	Dc	22

The protection by enclosure symbol ExtD is now being replaced by Exta, Extb or Extc.

The PL7 Series of boxes are approved to the latest standards and are marked as follows:-

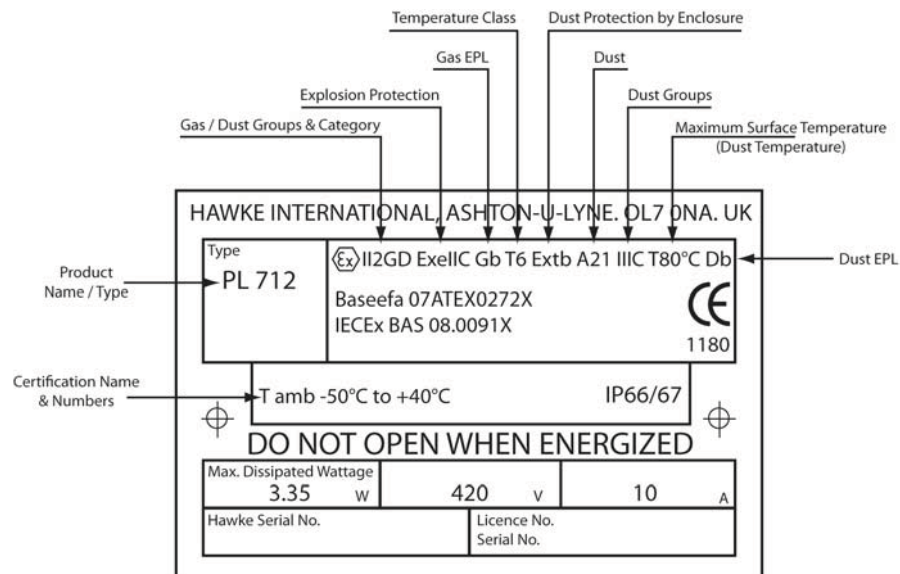

7.0 CE Marking

The CE Marking is intended to facilitate the free movement of products within the European Union. By affixing CE marking to products, the manufacturer is making a legal declaration that the product meets with the appropriate requirements of all relevant European Directives. CE marking only applies to products within the scope of the Directives. It should not be applied to products if they are outside the scope of the Directives.

7.1 EMC, Electromagnetic Compatibility Directive

Most electrical and electronic products made or sold in the EU must:

- Be constructed so they do not cause excessive electromagnetic interference and are not unduly affected by electromagnetic interference;
- In the case of certain radio-transmitting equipment, be subject to EC type examination by a notified body; and
- Carry CE marking

Cable glands are not considered to come within the scope of the Directive, however Hawke International have carried out independent third-party testing on the EMC shielding effectiveness of armoured type cable glands fitted onto single wire armoured and braided-type cables. The electromagnetic ingress between the cable sample (perfect connection) and that of the cable sample fitted with the cable gland was of such a small magnitude that it could be regarded as within acceptable uncertainty of measurement. As such, it can be concluded that the shielding effectiveness of single wire armoured or braided cable is maintained when fitted with an appropriate Hawke armoured type cable gland.

7.2 Low Voltage Directive

The Low voltage Directive 73/23/EEC embodies a number of principles: -

- Only electrical equipment that does not jeopardise the safety of people, domestic animals and property, is permitted on the market.
- Only electrical equipment, that satisfies the CE marking requirements of the LVD, is in compliance.
- Electrical equipment is not required to be tested or marked for approval by an independent third party.
- Enforcement is the responsibility of each member state within its national jurisdiction.
- The regulations apply to all electrical equipment, except where extensions apply, that is designed for use between 50 and 1000 volts AC or 75 and 1500 volts DC.
- Only components, which are in themselves “electrical equipment”, need satisfy the Low Voltage Directive.

Cable glands are not in themselves “electrical equipment” and therefore do not fall within the scope of the LVD.



8.0 Certification/Listing/Approvals

Electrical equipment for use in potentially explosive atmospheres is usually certified, listed or approved by a recognised Certification Body or Test House. In Europe, there are numerous Certification Bodies such as Baseefa and SIRA in the UK. In North America, there are many recognised Certification Bodies and testing laboratories such as UL, FM and the CSA. The definition of “Approved” by the NEC is “Acceptable to the authority having jurisdiction”. The definition “Listed” by the NEC is “Equipment, materials or services included in a list published by an organisation that is acceptable to the authority having jurisdiction”. Further information is given in the NEC.





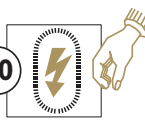
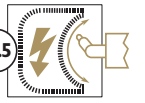

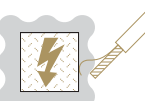
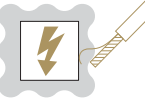
9.0 CENELEC and IEC Degree of Protection , IP Code

The standard IEC/EN 60529 describes a system for classifying the degrees of protection provided by the enclosures of electrical equipment as follows:-

First Number

0		Non-protected	Protection of persons against access to hazardous parts inside the enclosure and against solid foreign objects
1		Protected against objects of 50mm diameter and greater	An object probe, sphere of 50mm diameter, shall not fully penetrate
2		Protected against solid foreign objects of 12.5mm diameter and greater	An object probe, sphere of 12.5mm diameter, shall not fully penetrate
3		Protected against solid foreign objects of 2.5mm diameter and greater	An object probe, sphere of 2.5mm diameter, shall not penetrate at all
4		Protected against solid foreign objects of 1.0mm diameter and greater	An object probe, sphere of 1.0mm diameter, shall not penetrate at all
5		Dust-protected	Ingress of dust is not totally prevented, but dust shall not penetrate in a quantity to interfere with satisfactory operation of apparatus or to impair safety
6		Dust-tight	No ingress of dust

Second Number

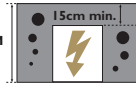
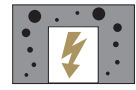
0		Non-protected	Protection of the equipment inside the enclosure against harmful effects due to the ingress of water
1		Protected against vertically falling water drops	Vertically falling drops shall have no harmful effects
2		Protected against vertically falling water drops when enclosure tilted up to 15°	Vertically falling drops shall have no harmful effects when the enclosure is tilted at any angle up to 15° on either side of the vertical
3		Protected against spraying water	Water sprayed at an angle up to 60° on either side of the vertical shall have no harmful effects
4		Protected against splashing water	Water splashed against the enclosure from any direction shall have no harmful effects
5		Protected against water jets	Water projected in jets against the enclosure from any direction shall have no harmful effects
6		Protected against powered water jets	Water projected in powerful jets against the enclosure from any direction shall have no harmful effects
7		Protected against the effects of temporary immersion in water for 30 mins	Ingress of water in quantities causing harmful effects shall not be possible when the enclosure is temporarily immersed in water under standardised conditions of pressure and time
8		Protected against the effects of continuous immersion in water	Ingress of water in quantities causing harmful effects shall not be possible when the enclosure is continuously immersed in water under conditions which shall be agreed between manufacturer and user but which are more severe than for numeral 7

Typical Designation : IP66

The protection of the enclosure and the equipment inside against external influences or conditions, such as: mechanical impacts, corrosion, corrosive solvents, solar radiation, icing moisture (e.g. produced by condensation), and explosive atmospheres, are matters that should be dealt with by the relevant product Standard.

There are additional and supplementary optional letters to the above coding; these designators are A, B, C & D and H, M, S & W, and further information can be found in the relevant Standard(s).

9.1 Deluge Ingress Protection

On offshore facilities, equipment may be located in areas subject to emergency deluge systems. Equipment that has been evaluated as certified for use in hazardous areas may not be suitable for use in these locations. A testing method for electrical equipment to be installed in areas subject to deluge systems, DTS01, has been prepared by the Explosion and Fire Hazards Group of ERA Technology (now known as ITS) in collaboration with Shell UK Exploration and Production Ltd.

Testing includes: -

- Energising the equipment (where appropriate) for 60 minutes prior to the deluge test, then interrupting the electrical power at the start of the deluge test and resuming after 60 minutes until the completion of the deluge test.
- Carrying out insulation resistance testing before and after pre-conditioning and after the deluge test, where applicable.
- Carrying out pre-conditioning by exposure to vibration and thermal ageing at 90% relative humidity and at a temperature 20k above the equipments maximum service temperature and/or at least 80°C of any appropriate seals.
- Carrying out deluge test using a deluge chamber fitted with deluge nozzles that apply a salt water solution deluge pressure within the range of 3.5 bar to 4.5 bar at a water temperature in the range of 5°C to 10°C for 3-hours.

10.0 IECEx Scheme

The objective of the IECEx Scheme is to facilitate international trade in electrical equipment intended for use in potentially explosive atmospheres by eliminating the need for multiple national certification. The IECEx Scheme provides a means for manufacturers to obtain Certificates of Conformity that will be accepted at national level in all participating countries. A Certificate of Conformity may be obtained from any certification body accepted into the scheme. The objective of the IECEx Scheme is world-wide acceptance of one standard, one certificate, and one mark.

For the IEC scheme to achieve its objective, every applicable national standard will need to be identical to the corresponding IEC standard. A transition period will be necessary to allow time for participating IECEx Scheme countries to align their national standards with the IEC standards and work towards national acceptance of IECEx Certificates of Conformity and the IECEx mark.

11.0 North American Hazardous (Classified) Locations

11.1 Area Classification

Area classification is the division of a facility into a two or three-dimensional hazardous location, a non-hazardous location and the sub-division of the hazardous location into 'Divisions' or 'Zones'.

In the United States of America, hazardous (classified) locations may be sub-divided as follows: -

For further information on the classification of hazardous (classified) locations, see:-

CLASS I: FLAMMABLE GASES, VAPOURS OR LIQUIDS	Division 1 Where ignitable concentrations of flammable gases, vapours or liquids can exist all or some of the time or some time under normal operating conditions	Zone 0 Where ignitable concentrations of flammable gases, vapours or liquids can exist all of the time or for long periods <u>at a time</u> under normal operation conditions.
	Division 2 Where ignitable concentrations of flammable gases, vapours or liquids are not likely to exist under normal operating conditions	Zone 1 Where ignitable concentrations of flammable gases, vapours or liquids can exist all of the time or for long periods <u>at a time</u> under normal operating conditions
		Zone 2 Where ignitable concentrations of flammable gases, vapours or liquids are not likely to exist under normal operating conditions
CLASS II: COMBUSTIBLE DUSTS	Division 1 Where ignitable concentrations of combustible dusts can exist all or some of the time under normal operating conditions	Zone classifications do not currently apply
	Division 2 Where ignitable concentrations of combustible dusts are not likely to exist under normal operating conditions	
CLASS III: IGNITABLE FIBRES AND FLYINGS	Division 1 Where ignitable concentrations of fibres and flyings can exist all or some of the time under normal operating conditions	Zone classifications do not currently apply
	Division 2 Where ignitable concentrations of fibres and flyings are not likely to exist under normal operating conditions	

- NEC, NFPA 70 National Electric Code, NFPA 70
- NFPA 30 Flammable and Combustible Liquids Code
- NFPA 497 Recommended Practice for the Classification of Flammable Liquids, Gases or Vapours and of Hazardous (Classified) Locations for Electrical Installations in chemical Process Areas

- NFPA 499 Recommended Practice for the Classification of Combustible Dusts and of Hazardous (Classified) Locations for Electrical Installations in Chemical Process Areas
- ANSI/API RP500 Recommended Practice for Classification of Locations for Electrical Installations at Petroleum Facilities Classified as Class I, Division 1 and Division 2
- ANSI/API RP505 Classification of Locations for Electrical Installations at Petroleum Facilities Classified as Class I, Zone 0, Zone 1 or Zone 2

Apparatus for use in Class I, Division 1

- Explosion-proof
- Intrinsically Safe
- Purged / Pressurised (Type X or Y)

Apparatus for use in Class I, Zone 0

- Intrinsic Safety AEx ia
- Class I, Division 1 Intrinsically Safe

Apparatus for use in Class I, Division 2

- Any Class I, Division 1 Method
- Non-incendive
- Non-sparking Device
- Purged / Pressurised (Type Z)
- Hermetically Sealed
- Oil Immersion

Apparatus for use in Class I, Zone 1

- Any Class I, Zone 0 Method
- Any Class I, Division 1 Method
- Flameproof AEx d
- Increased Safety AEx e
- Intrinsic Safety AEx ib
- Purged / Pressurized AEx p
- Powder Filling AEx q
- Oil Immersion AEx o
- Encapsulation AEx m

Apparatus for use in Class I, Zone 2

- Any Class I, Zone 0 Method
- Any Class I, Division 1 Method
- Type of Protection AEx n

11.2 Apparatus Selection According to Class I

Intrinsically safe equipment listed for use in Class I, Division 1 locations for the same gas, or as permitted by Section 505.8 of the NEC, and with suitable temperature rating is permitted in Class I, Zone 0 locations.

Equipment approved for use in Class I, Division 1, or listed for use in Class I, Zone 0 locations for the same gas, or as permitted by Section 505.8 of the NEC, and with a suitable temperature rating is permitted in Class I, Zone 1 locations.

Equipment approved for use in Class I, Division 1 or Division 2 locations for the same gas, or as permitted by Section 505.8 of the NEC, and with a suitable temperature rating is permitted in Class I, Zone 2 locations.

Equipment listed as classified for use in Class I locations is not necessarily acceptable for Class II locations as it may not be dust-tight, or operate at a safe temperature with a dust covering.

11.3 Apparatus Selection According to the Ignition Temperature of the Gas or Vapour

The equipment must be selected so that its maximum surface temperature will not reach the ignition temperature of any gas or vapour that may be present.

TEMPERATURE CLASS OF ELECTRICAL APPARATUS	MAXIMUM SURFACE TEMPERATURE OF ELECTRICAL APPARATUS	IGNITION TEMPERATURE OF GAS OR VAPOUR
T1	450°C	> 450°C
T2	300°C	> 300°C
T2A	280°C	> 280°C
T2B	260°C	> 260°C
T2C	230°C	> 230°C
T2D	215°C	> 215°C
T3	200°C	> 200°C
T3A	180°C	> 180°C
T3B	165°C	> 165°C
T3C	160°C	> 160°C
T4	135°C	> 135°C
T4A	120°C	> 120°C
T5	100°C	> 100°C
T6	85°C	> 85°C

Low ambient conditions require special consideration. Explosion proof of dust ignition proof equipment may not be suitable for use at temperatures lower than -25°C (-13°F) unless they are identified for low temperature service. Unless the equipment is marked otherwise, it is for use only in an ambient temperature range of -25°C (-13°F) to +40°C (+104°F).

Equipment that is approved for Class I and Class II should be marked with the maximum safe operating temperature.

For information regarding data for flammable gases and vapours, see NFPA 497 and NFPA 325.

11.4 Apparatus Selection According to the Ignition Temperature of the Dust

The equipment must be selected so that its maximum surface temperature will be less than the ignition temperature of the specific dust.

For information regarding data for dusts, see NFPA 499.

11.5 Apparatus Selection According to Apparatus Grouping

Equipment that is approved for Class I and Class II should be marked with the maximum safe operating temperature.

The grouping of Class I gases and vapours are classified into Categories A, B, C, & D		The grouping of Class II dusts are classified into Categories E, F & G	
GAS / VAPOUR GROUP	TYPICAL GAS	DUST GROUP	TYPICAL ATMOSPHERES CONTAINING
A	Acetylene	E	Combustible Metal Dusts
B	Hydrogen	F	Coal Dusts
C	Ethylene	G	Grain Dusts
D	Propane		

11.6 Apparatus Construction Standards

- ANSI / UL 1203 Explosion-Proof and Dust-Ignition-Proof Electrical. Equipment for use in Hazardous (Classified) Locations.
- ANSI/ISA-12.12.01-2007 Nonincendive Electrical Equipment for Use in Class I and II, Division 2 and Class III, Divisions 1 and 2 Hazardous (Classified) Locations.
- ANSI/NFPA 496 Standard for Purged and Pressurised Enclosures for Electrical Equipment.
- ANSI/UL 913 Intrinsically Safe Apparatus and Associated Apparatus for use in Class I, II and III, Division 1, Hazardous Locations.
- ANSI/UL 698 Industrial Control Equipment for use in Hazardous (Classified) Locations.
- ANSI/UL 2225 Cables and Cable-Fitting for use in Hazardous (Classified) Locations.
- UL 1604 Electrical Equipment for use in Class I and II, Division 2, and Class III Hazardous (Classified) Locations.
- ANSI/UL 60079 Electrical Equipment for use in Class I, Zone 0, 1 and 2 Hazardous (Classified) Locations,
- ISA 60079-0 Electrical Apparatus for Gas Atmospheres – Part 0: General Requirements.
- ISA 60079-1 Explosive Atmospheres – Part 1: Equipment Protection by Flameproof Enclosures ‘d’.
- ISA 60079-7 Explosive Atmospheres – Part 7: Equipment Protection by Increased Safety ‘e’.

11.7 Installation Standards and Codes

- NEC, NFPA 70 National Electrical Code (NEC)
- USCG 45 CFR Parts 110 – 113 - Shipping, Sub-Chapter J, Electrical Engineering
- ANSI / API RP 14F Recommended Practice for Design and Installation of Electrical Systems for Fixed and Floating Offshore Petroleum Facilities for Unclassified and Class I, Division 1 and 2 Locations.
- API RP 14RZ Recommended Practice for Design and Installation of Electrical Systems for Fixed and Floating Offshore Petroleum Facilities for Unclassified and Class I, Zone 0, 1 and 2 Locations.

12.0 Wiring Systems

Cable systems and accessories should be installed in positions that prevent them from being subject to mechanical damage, corrosion, chemical attack, heat and other detrimental environmental conditions. Selection of the wiring system and cable type must consider these influences and where exposure to such conditions are avoidable, protective measures such as minimising the risk of mechanical damage by the use of appropriate armoured cable types should be considered.

The connection of cables and conduits to the electrical apparatus must be in accordance with the requirements of the relevant type of protection and installation rules.

12.1 National Electrical Code (NEC) Zone Wiring Methods

In Class 1, Division 1 locations, the NEC permits the following wiring methods:-

- **Type MC cable**, listed for use, with a gas / vapour tight continuous corrugated aluminium sheath, an overall jacket of suitable polymeric material, separate grounding conductors, in accordance with Sections 250-122 and 501.10 of the NEC, and provided with termination fittings listed for the application, e.g. Hawke type 711 cable gland/connector.
- **Type ITC cable**, listed for use with a gas / vapour tight continuous aluminium sheath, an overall jacket of suitable polymeric material in accordance with Section 501.10 of the NEC and provided with termination fittings listed for the application, e.g. Hawke type 711 cable gland/connector.
- **Threaded rigid metal conduit**, threaded steel intermediate metal conduit, or type MI cable with termination fittings approved for the location and in accordance with Section 501.10 of the NEC.

All boxes, fittings and joints must be explosion-proof.

In Class 1, Division 2 locations, the NEC permits the following wiring methods:-

- **Type MC, MV, ITC, PLTC, TC or MI cable** with approved termination fittings in accordance with Section 501.10 of the NEC.
- **Threaded rigid metal conduit**, threaded steel intermediate metal conduit.
- Non-incendive field wiring using any of the methods suitable for wiring in ordinary locations in accordance with Section 501.10 of the NEC.

Boxes, fittings and joints need not be explosion-proof except as required by the NEC code.

12.2 Cable Seals, Class 1, Division 1

Cables must be sealed at the termination. The sealing fitting, e.g. a barrier type cable gland, must provide a seal against the passage of gas or vapours through the fitting. Type MC cables with multi-conductors, a gas / vapour tight continuous corrugated aluminium sheath and an overall jacket with a suitable polymeric material must be sealed with an appropriate fitting, e.g. Hawke type 711, after removing the cables jacket and all other coverings so that the sealing compound surrounds each individual insulated conductor. Cables with twisted pairs and shielded cables require the removal of the shielded material or separation of the twisted pairs unless the fitting, e.g. cable gland, is an approved means which minimises the entrance of gases or vapours and prevents propagation of flame into the cable core. If the fitting complies with this requirement, there will be information provided in the fittings installation instructions detailing the means to achieve the seal. Additional testing may be required on the fitting and the style and type of cable to show compliance with the sealing requirements.

A NRTL approved cable sealing fitting e.g. barrier type cable gland, must be fitted onto cables that enter explosion-proof enclosures.

Further guidance is given in Section 501.5(d) of the NEC.

12.3 Cable Seals, Class 1, Division 2

Cables must be sealed at the point of entrance into enclosures **that require to be approved for Class I locations**. A sealing fitting must comply with the above criteria given in 'Cable Seals, Class I, Division 1'.

A NRTL approved cable sealing fitting e.g. barrier type cable gland, must be fitted onto cables where they enter explosion-proof enclosures.

12.4 United States Coast Guard Wiring Methods

Electrical installations in hazardous (classified) locations must comply with the general requirements of Section 43 of the IEEE standard 45 and either the NEC Articles 500 - 505 or **IEC 60079 series publications**.

In hazardous (classified) locations, the USCG 46 CFR Sub-Chapter J, permits the following wiring methods: -

- Marine shipboard cables that are permitted for use, must meet all the requirements of either IEEE standard 45, IEC 60092-3 and the applicable flammability requirements. Cables constructed to IEC 60092-3 must meet with the flammability requirements of IEC 60332-3, Category A.
- Metal-clad (type MC) cables that are permitted for use, must have a continuous corrugated gas tight, vapour-tight, and water-tight sheath of aluminium or other suitable metal that is close fitting around the conductors and with fillers. The MC cable must have an overall jacket of an impervious PVC or thermoset material and be certified or listed to UL 1569.

For information on other wiring methods permitted and further information, refer to Subpart 111-60 of the USCG 46 CFR.

Each cable entry into explosion-protected equipment must be made with an appropriate fitting or cable gland that maintains the integrity of the equipment.

12.4.1 Cables with multi-conductors that enter explosion-proof enclosures, must be sealed with an appropriate fitting, e.g. barrier type cable gland, after removing the cables jacket and all other coverings so that the sealing compound surrounds each individual insulated conductor. Cables with twisted pairs and shielded cables require the removal of the shielded material or separation of the twisted pairs unless the fitting, e.g. barrier type cable gland, is an approved means which minimises the entrance of gases or vapours and prevents propagation of flame into the cable core. If the fitting complies with this requirement, there will be information provided in the fittings installation instructions detailing the means to achieve the seal. Additional testing may be required on the fitting, and the style and type of cable to show compliance with the sealing requirements.

The equipment grounding path should be carefully considered when using Shipboard Cables or type TC cables, as these may not inherently provide a grounding means. The armour of Shipboard Cables should be grounded but can not be used as the grounding conductor. An appropriate sized grounding conductor should be included in each cable.

12.5 American Petroleum Institute Wiring Methods

12.5.1 Class 1, Division 1

The API RP 14F Recommended Practice for the design and installation of electrical systems for fixed and floating offshore petroleum facilities recommends the following wiring methods for hazardous (classified) locations.

- Type MC-HL metal clad cables as defined in UL 2225.
- Armoured marine shipboard cable with an overall impervious sheath over the armour, constructed in accordance with UL 1309, and listed as 'Shipboard Cable Marine' by a National Recognised Testing Laboratory (NRTL). This wiring method is a departure from the NEC.
- Type ITC cable that is NRTL - listed for use in Class I, Division 1 locations with a gas / vapour tight continuous corrugated aluminium sheath and with an overall PVC or other suitable polymeric jacket.
- Threaded rigid copper-free aluminium conduit.
- Threaded rigid steel, hot dipped galvanized conduit, coated with PVC, or other suitable material, and with the interior protected by an additional means.

An NRTL approved cable sealing fitting, e.g. barrier type cable gland complying with UL 2225, must be fitted onto cables where they enter explosion-proof enclosures.

For further information and other wiring methods acceptable for Division 1, refer to Clause 6.4.2.2 of the API RP14F.

For fitting requirements of cables with multi-conductors, twisted pairs or shielded conductors into explosion proof equipment. See clause 12.4.1.

12.5.2 Class 1, Division 2

- Wiring methods as recommended for use in Division 1.
- Type MC cable with a gas / vapour tight continuous corrugated aluminium sheath, an overall PVC or other suitable polymeric jacket, and grounding conductors in accordance with NEC 250-122.
- Non-armoured marine shipboard cable, with an overall impervious jacket in accordance with UL 1309 and listed as 'Shipboard Cable Marine' by a NRTL. This wiring method is a departure from the NEC.

Additional wiring methods acceptable for Division 2 include type PLTC, ITC, TC and MV cables. It is recommended that an overall PVC or other suitable polymeric material jacket is included for these cable types.

For additional information, refer to Clause 6.4.2.3 of API RP14F.

In Division 1 locations, all electrical equipment (except intrinsically safe systems and equipment inside purged enclosures) should be explosion-proof.

In Division 2 locations, the equipment does not need to be explosion-proof, except where necessary to maintain the integrity of the installation.

Further information on the use of equipment is given in Clause 6.4.7 of API RP14F.

An NRTL approved cable sealing fitting, e.g. barrier type cable gland complying with UL 2225, must be fitted onto cables where they enter explosion-proof enclosures.

For fitting requirements of cables with multi-conductors, twisted pairs or shielded conductors into explosion proof equipment. See clause 12.4.1.

12.5.3 Class 1, Zones 0, 1 and 2

The API RP 14 FZ, Recommended Practice for the design and installation of electrical systems for fixed and floating offshore petroleum facilities for unclassified and Class I, Zone 0, Zone 1 and Zone 2 locations, recommends the following wiring methods for hazardous (classified) locations.

12.5.4 Class 1, Zone 1

- Type MC-HL metal clad cables as defined in UL 2225.
- Armoured marine shipboard cable with an overall impervious sheath over the armour, constructed in accordance with UL 1309, and listed as “Shipboard Cable Marine” by a National Recognised Testing Laboratory (NRTL). This wiring method is a departure from the NEC.
- Type ITC cable that is NRTL - listed for use in Class 1, Division 1 locations with a gas/vapour tight continuous corrugated aluminium sheath and with an overall PVC or other suitable polymeric jacket.
- Threaded rigid copper-free aluminium conduit.
- Threaded rigid steel, hot dipped galvanized conduit, coated with PVC, or other suitable material, and with the interior protected by an additional means.

Non-armoured marine shipboard cable, with an overall impervious jacket in accordance with UL 1309 and listed as ‘Shipboard Cable Marine’ by a NRTL. This wiring method is a departure from the NEC.

For further information and other wiring methods acceptable for Zone 1, refer to Clause 6.4.2.2 of the API RP14FZ.

For fitting requirements of cables with multi-conductors, twisted pairs or shielded conductors into explosion proof equipment. See clause 12.4.1.

12.5.5 Class 1, Zone 2

- Wiring methods as recommended for use in Zone 1.
- Type MC cable with a gas / vapour tight continuous corrugated aluminium sheath, an overall PVC or other suitable polymeric jacket, and grounding conductors in accordance with NEC 250-122.
- Non-armoured marine shipboard cable, with an overall impervious jacket in accordance with UL 1309 and listed as ‘Shipboard Cable Marine’ by a NRTL. This wiring method is a departure from the NEC.

Additional wiring methods acceptable for Zone 2 include type PLTC, ITC, TC and MV cables. It is recommended that an overall PVC or other suitable polymeric material jacket is included for these cable types.

For additional information, refer to Clause 6.4.2.3 of API RP14FZ.

Further information on the use of equipment is given in Clause 6.4.7 of API RP14FZ.

An NRTL approved cable sealing fitting, e.g. barrier type cable gland complying with UL 2225, must be fitted onto cables where they enter explosion-proof enclosures.

For fitting requirements of cables with multi-conductors, twisted pairs or shielded conductors into explosion proof equipment. See clause 12.4.1.

Where cables enter equipment which is permitted for use in Zone 2 or unclassified areas and that is not explosion-proof, a suitable cable fitting e.g. cable gland design, need not be explosion-proof, except when necessary to maintain the integrity of the enclosure and as required by the Recommended Practice.

In unclassified and Zone 2 locations, when the metallic sheath is approved as a grounding conductor, the continuous metal sheath of the MC cable or the combined metallic sheath and grounding conductors may be used as the grounding conductor when used with termination fittings that are NRTL listed to UL 514B.

12.6 National Electrical Code (NEC) Zone Equipment Marking

Equipment that is listed for use in Class I Zones, as permitted by the NEC, should be marked as follows:-

- Class 1, Zone 0 or Class 1, Zone 1 or Class 1, Zone 2
- Applicable gas classification group(s)
- Temperature classification

E.g.

CLASS 1, ZONE 1	AEx	e	II	T6
Area Classification	Symbol for equipment built to American Standards	Type(s) of Protection	Gas Classification Groups	Temperature Classification

12.7 National Electrical Code (NEC) Division Equipment Marking

Equipment that is approved for use in Class I, Class II or Class III, Division 1 or 2 as permitted by the NEC may be marked as follows:-

- Class I or Class II or Class III, or a combination where appropriate.
- Division 1 or 2 equipment not marked to indicate a Division or marked Division 1 is suitable for both Division 1 and 2 locations as defined in the NEC.
- Group Classification.
- Operating temperature or temperature range, or as permitted by the NEC.

12.8 North American Ingress Protection

12.8.1 Non-Hazardous Locations

NEMA ENCLOSURE TYPE NO.	APPLICATIONS
1	Enclosures constructed for indoor use to provide a degree of protection to personnel against access to hazardous parts and to provide a degree of protection of the equipment inside the enclosure against ingress of solid foreign objects (falling dirt).
2	Enclosures constructed for indoor use to provide a degree of protection to personnel against access to hazardous parts; to provide a degree of protection of the equipment inside the enclosure against ingress of solid foreign objects (falling dirt); and to provide a degree of protection with respect to harmful effects on the equipment due to the ingress of water (dripping and light splashing).
3	Enclosures constructed for either indoor or outdoor use to provide a degree of protection to personnel against access to hazardous parts; to provide a degree of protection of the equipment inside the enclosure against ingress of solid foreign objects (falling dirt and windblown dust); to provide a degree of protection with respect to harmful effects on the equipment due to the ingress of water (rain, sleet, snow); and that will be undamaged by the external formation of ice on the enclosure.
3R	Enclosures constructed for either indoor or outdoor use to provide a degree of protection to personnel against access to hazardous parts; to provide a degree of protection of the equipment inside the enclosure against ingress of solid foreign objects (falling dirt); to provide a degree of protection with respect to harmful effects on the equipment due to the ingress of water (rain, sleet, snow); and that will be undamaged by the external formation of ice on the enclosure.
3S	Enclosures constructed for either indoor or outdoor use to provide a degree of protection to personnel against access to hazardous parts; to provide a degree of protection of the equipment inside the enclosure against ingress of solid foreign objects (falling dirt and windblown dust); to provide a degree of protection with respect to harmful effects on the equipment due to the ingress of water (rain, sleet, snow); and for which the external mechanism(s) remain operable when ice laden.
3X	Enclosures constructed for either indoor or outdoor use to provide a degree of protection to personnel against access to hazardous parts; to provide a degree of protection of the equipment inside the enclosure against ingress of solid foreign objects (falling dirt and windblown dust); to provide a degree of protection with respect to harmful effects on the equipment due to the ingress of water (rain, sleet, snow); that provides an additional level of protection against corrosion and that will be undamaged by the external formation of ice on the enclosure.

3RX	Enclosures constructed for either indoor or outdoor use to provide a degree of protection to personnel against access to hazardous parts; to provide a degree of protection of the equipment inside the enclosure against ingress of solid foreign objects (falling dirt); to provide a degree of protection with respect to harmful effects on the equipment due to the ingress of water (rain, sleet, snow); that will be undamaged by the external formation of ice on the enclosure that provides an additional level of protection against corrosion; and that will be undamaged by the external formation of ice on the enclosure.
3SX	Enclosures constructed for either indoor or outdoor use to provide a degree of protection to personnel against access to hazardous parts; to provide a degree of protection of the equipment inside the enclosure against ingress of solid foreign objects (falling dirt and windblown dust); to provide a degree of protection with respect to harmful effects on the equipment due to the ingress of water (rain, sleet, snow); that provides an additional level of protection against corrosion; and for which the external mechanism(s) remain operable when ice laden.
4	Enclosures constructed for either indoor or outdoor use to provide a degree of protection to personnel against access to hazardous parts; to provide a degree of protection of the equipment inside the enclosure against ingress of solid foreign objects (falling dirt and windblown dust); to provide a degree of protection with respect to harmful effects on the equipment due to the ingress of water (rain, sleet, snow, splashing water, and hose directed water); and that will be undamaged by the external formation of ice on the enclosure.
4X	Enclosures constructed for either indoor or outdoor use to provide a degree of protection to personnel against access to hazardous parts; to provide a degree of protection of the equipment inside the enclosure against ingress of solid foreign objects (windblown dust); to provide a degree of protection with respect to harmful effects on the equipment due to the ingress of water (rain, sleet, snow, splashing water, and hose directed water); that provides an additional level of protection against corrosion; and that will be undamaged by the external formation of ice on the enclosure.
5	Enclosures constructed for indoor use to provide a degree of protection to personnel against access to hazardous parts; to provide a degree of protection of the equipment inside the enclosure against ingress of solid foreign objects (falling dirt and settling airborne dust, lint, fibres, and flyings); and to provide a degree of protection with respect to harmful effects on the equipment due to the ingress of water (dripping and light splashing).
6	Enclosures constructed for either indoor or outdoor use to provide a degree of protection to personnel against access to hazardous parts; to provide a degree of protection of the equipment inside the enclosure against ingress of solid foreign objects (falling dirt); to provide a degree of protection with respect to harmful effects on the equipment due to the ingress of water (hose directed water and the entry of water during occasional temporary submersion at a limited depth); and that will be undamaged by the external formation of ice on the enclosure.

6P	Enclosures constructed for either indoor or outdoor use to provide a degree of protection to personnel against access to hazardous parts; to provide a degree of protection of the equipment inside the enclosure against ingress of solid foreign objects (falling dirt); to provide a degree of protection with respect to harmful effects on the equipment due to the ingress of water (hose directed water and the entry of water during prolonged submersion at a limited depth); that provides an additional level of protection against corrosion and that will be undamaged by the external formation of ice on the enclosure.
12	Enclosures constructed (without knockouts) for indoor use to provide a degree of protection to personnel against access to hazardous parts; to provide a degree of protection of the equipment inside the enclosure against ingress of solid foreign objects (falling dirt and circulating dust, lint, fibres, and flyings); and to provide a degree of protection with respect to harmful effects on the equipment due to the ingress of water (dripping and light splashing).
12K	Enclosures constructed (with knockouts) for indoor use to provide a degree of protection to personnel against access to hazardous parts; to provide a degree of protection of the equipment inside the enclosure against ingress of solid foreign objects (falling dirt and circulating dust, lint, fibres, and flyings); and to provide a degree of protection with respect to harmful effects on the equipment due to the ingress of water (dripping and light splashing).
13	Enclosures constructed for indoor use to provide a degree of protection to personnel against access to hazardous parts; to provide a degree of protection of the equipment inside the enclosure against ingress of solid foreign objects (falling dirt and circulating dust, lint, fibres, and flyings); to provide a degree of protection with respect to harmful effects on the equipment due to the ingress of water (dripping and light splashing); and to provide a degree of protection against the spraying, splashing, and seepage of oil and non-corrosive coolants.

12.8.2 Hazardous locations

ENCLOSURE TYPE NO.	APPLICATION
7	For indoor use in hazardous locations classified as Class I, Division 1, Groups A, B, C or D as defined in NFPA 70.
8	For indoor use in hazardous locations classified as Class II, Division 1, Groups E, F or G as defined in NFPA 70.
8	For indoor use in hazardous locations classified as Class II, Division 1, Groups E, F or G as defined in NFPA 70.

Further information can be found in NEMA Standard Publication 250 and UL 50 Standard Publication.

The enclosures are designed to protect and to provide additional protection as stated in the adjacent table:-

The IEC and CENELEC 60529 Standards and NEMA degrees of protection can not be compared as equivalent ratings. The NEMA Standard includes test for environmental conditions such as mechanical damage, corrosion, rusting, ice formation etc.

NEMA ENCLOSURE TYPE	IEC / EN 60529
1	IP10
2	IP11
3	IP54
3R	IP14
3S	IP54
4 and 4X	IP55
5	IP52
6 and 6P	IP67
12 and 12K	IP52
13	IP54

13.0 Abbreviations, Acronyms and Definitions

ABS	American Bureau of Shipping. ABS is a ship classification society involved with establishing and administering of standards and rules for marine vessels and structures.
AEx	A marking prefix for apparatus complying with one or more types of explosion protection techniques for installation in accordance with Article 505 of the NEC.
ANSI	American National Standards Institute.
API	American Petroleum Institute.
ATEX	EU Directive 94/9/EC Equipment and protective systems intended for use in potentially explosive atmospheres.
Baseefa	British Approvals Service for Electrical Equipment in Flammable Atmospheres. Provide a range of testing and certification services primarily related to equipment and systems intended for use in potentially explosive atmospheres.
CEC	Canadian Electrical Code. Part 1, CSA Standard C22.1-09, is a safety standard for the installation and maintenance of electrical equipment.
CEN	European Committee for Standardisation.

CENELEC	The European Committee for Electrotechnical Standardization was created in 1973. CENELEC is a non-profit technical organization consisting of over 30 European countries, with an additional 10 neighbouring countries participating in CENELEC work with an Affiliate status.
CEPEL	Centro de Pesquisas de Energia Electrica (Brazil). In Brazil, all electrical or electronic equipment for use in potentially explosive atmospheres should be certified by a Brazilian certification body recognised by INMETRO. CEPEL is an accredited body that is able to issue relevant certification.
CFR	Code of Federal Regulations.
Cold Flow	Certain types of cable employ materials that can exhibit 'cold flow' characteristics that could have adverse effects on the protection of the apparatus. Where such cable is used, a suitable cable entry device should be employed, for example cable entry devices not employing compression seals that act upon the part(s) of the cable having 'cold flow' characteristics. 'Cold flow' can be more fully described as thermoplastic materials that flow when subjected to pressure at ambient temperature.
CSA	Canadian Standards Association. A service offered that includes testing and certification services to US and Canadian Standards, as well as international certification through agreements with other approval authorities.
DNV	Det Norske Veritas.
EPL	Explosion Protection Level.
Ex	A marking prefix for apparatus complying with one or more types of explosion protection techniques in accordance with IEC standards.
Explosionproof	A term used to describe equipment that is capable of withstanding an explosion of a specified gas or vapour that may occur within it and preventing the ignition of a specified gas or vapour surrounding it.
Flameproof	A type of protection of electrical apparatus in which the enclosure will withstand an internal explosion of a flammable mixture which has penetrated into the interior, without suffering damage and without causing ignition, through any joints or structural openings in the enclosure, of an external explosive atmosphere consisting of one or more of gases or vapours for which it is designed.
FM Global	Factory Mutual Research Corporation (USA). Services they offer include the testing and approval of electrical equipment in accordance with US and international Standards.
Hazardous Areas	Locations where fire or explosion hazards may exist due to the presence of flammable gases, vapours, mists, ignitable fibres or dusts.

IADC	International Association of Drilling Contractors.
IEC	International Electrotechnical Commission. Founded in 1906, the IEC is the world organisation that prepares international standards for all electrical, electronic and related technologies. The membership consists of more than 70 participating countries.
IECEX	The aim of the IECEX Scheme is to facilitate international trade in electrical equipment intended for use in potentially explosive atmospheres by eliminating the need for multiple national certificates.
Increased Safety	A type of protection applied to electrical apparatus that does not produce arcs or sparks in normal service and under specified abnormal conditions, in which additional measures are applied so as to give increased security against the possibility of excessive temperatures and of the occurrence of arcs and sparks.
INMETRO	Nacional de Metrologia, Normalização e Qualidade Industrial (Brazil).
Intrinsically Safe Systems	An assembly of interconnected items of apparatus which may comprise of intrinsically safe apparatus, associated apparatus and other apparatus, and interconnecting cables in which the circuits within those parts of the system that may be exposed to explosive gas atmospheres are intrinsically safe circuits.
Impervious Sheathed Cable	Cable constructed with an impervious metallic or non-metallic overall covering that prevents the entrance of gases, moisture or vapours into the insulated conductor or cable.
IP	A system of rating levels of Ingress Protection provided by the apparatus.
ISA	The International Society for Measurement and Control, a global, non-profit organization.
ISO	International Organizations for Standardization. Worldwide federation of national standard bodies from 162 countries. ISO's mission is to promote the development of standardization to facilitate international exchange of goods service.
ITS	Intertek Testing Services.
Marine Shipboard Cable	Impervious sheathed armoured or non-armoured cable constructed in accordance with UL 1209 / CSA C22.2 No. 245, except that an overall impervious sheath is required over the armoured construction, and listed as "Shipboard Cable, Marine" by a Nationally Recognised Testing Laboratory (NRTL).

Maximum Surface Temperature	The highest temperature of a surface accessible to a flammable mixture under conditions of operation and within the ratings of the equipment.
MC Cable	Metal-clad cable as defined by NEC Article 501.
MC-HL Cable	Metal-clad cable for hazardous locations as defined in UL 2225.
NEC	National Electric Code (ANSI / NFPA 70).
NEMA	National Electrical Manufacturer's Association.
NFPA	National Fire Protection Association.
NRTL	National Recognised Test Laboratories (US). Those recognised by the OSHA include CSA, FMRC and UL. The NRTL determines that the specific products meet the relevant standards of safety as required by the OSHA and that the products are safe for use in the U. S. workplace. For further information, refer to the OSHA website www.osha.gov
OSHA	Occupational Safety and Health Administration. Works with the U. S. Department of Labour National Recognised Test Laboratories (NRTL's) to ensure products safe for use in the U.S.
PLTC	Power limited tray cable as defined by NEC Article 725.
Potentially Explosive Atmosphere	A mixture with air, under atmospheric conditions, of flammable substances in the form of a gas, vapour, mist or dust in which after ignition, combustion spreads through the unconsumed mixture.
Restricted Breathing (ExnR)	Enclosure that is designed to restrict the entry of gases, vapours, dusts and mists.
SCS	SIRA Certification Service (UK). Provide a range of testing and certification services, and have agreements with other international approval authorities.
TC	Power and control cable as defined by NEC Article 336.
UL	Underwriters Laboratories Inc – USA.
ULc	Underwriters Laboratories Inc – Canada.
USCG	United States Coast Guard.